

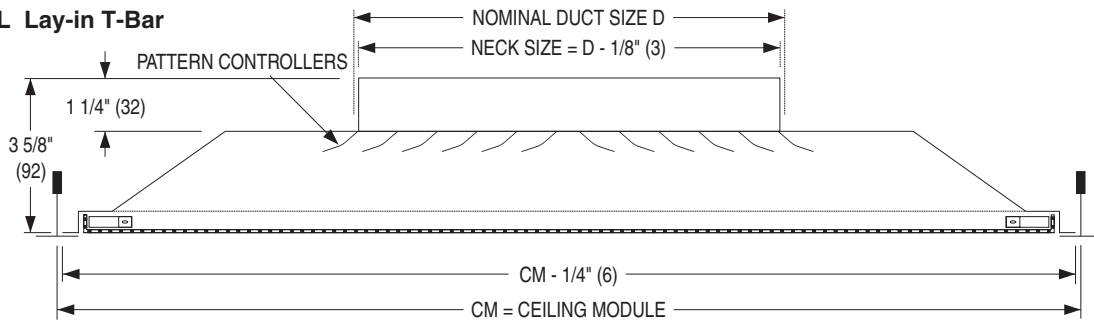

PERFORATED CEILING DIFFUSERS
SUPPLY • FLUSH FACE • ADJUSTABLE
STAR PATTERN CONTROLLER
MODELS: 4320S, 4320SA

TYPE L Lay-in T-Bar



Available Combinations of Ceiling Module vs. Neck Size

Ceiling Module CM		Nominal Duct Size D			
Imperial Modules	Metric Modules	Round Neck		Square Neck	
		Imperial Units (in.)	Metric Units (mm)	Imperial Units (in.)	Metric Units (mm)
12 x 12	300 x 300	6	152	6 x 6	152 x 152
24 x 24	600 x 600	6, 8	152, 203	6 x 6	152 x 152
		10, 12	254, 305	8 x 8	203 x 203
		14, 15	356, 381	10 x 10	254 x 254
		16	406	12 x 12	305 x 305

DESCRIPTION:

1. Material: Corrosion-resistant steel.
2. Designed to maximize throw, the diffuser features a stamped pattern controller mounted directly under the neck that produces a long throw 4-way 'Star Pattern'. The factory set pattern controller is easily rotated from side throw to corner throw in the field. Individual vanes can be field adjusted to produce a horizontal to vertical pattern or a 3-way horizontal pattern by turning one segment of blades in the opposite direction.
3. Removable face has concealed latches for easy access to optional damper.
4. Perforated face has 3/16" (5) diameter holes on 1/4" (6) staggered centers.
5. Excellent performance in VAV systems.
6. Standard finish is AW Appliance White.

OPTIONS:

- Aluminum perforated face/steel backpan. (Model 4320SA).
- Finish:
 - EX External Foil-Back Insulation, installed - R-4.2
 - EXB External Foil-Back Insulation, ships loose - R-4.2
 - MIB Molded Insulation Blanket - R-6.0 (24 x 24 only)
 - BA Black back pan and deflectors with Appliance White face.
 - SP Special _____.

Factory Set Four-Way Discharge Pattern:

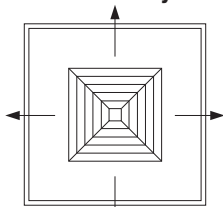

DPS, Side Throw

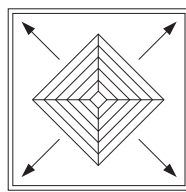

DPC, Corner Throw

Fineline® is a registered trademark of USG Interiors Inc.

TYPE S Surface Mount

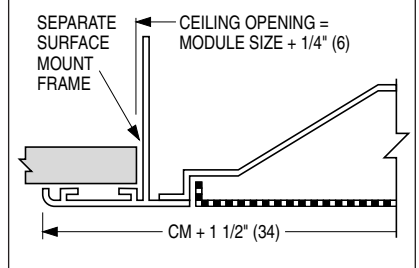

TYPE F Fineline® T-Bar

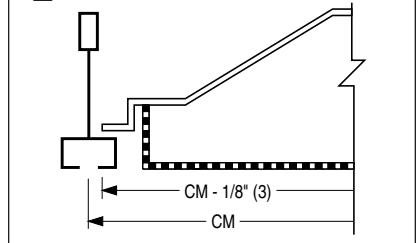

TYPE SP Spline

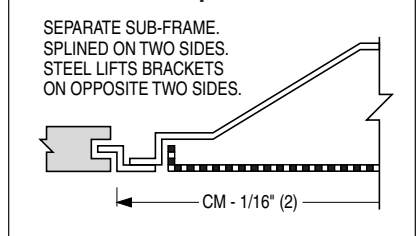

TYPE M Metal Pan (Snap-in)

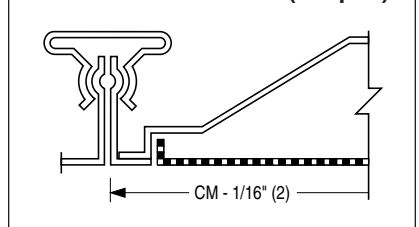

SCHEDULE TYPE:

PROJECT:

ENGINEER:

CONTRACTOR:

DATE

B SERIES

SUPERSEDES

DRAWING NO.

1 - 4 - 11

4300

NEW

4320S