



VAV LINEAR FLOOR DIFFUSERS WITH ACTUATOR
UNDERFLOOR AIR DISTRIBUTION SYSTEMS
VAV • COOLING ONLY • NON-DUCTED
MODEL: NLYD-VC

DESCRIPTION:

The Nailor NLYD Linear Floor Diffusers are designed for use in raised access floor air distribution systems. High quality, heavy duty, extruded aluminum linear grilles are featured providing an architecturally appealing face design that compliments contemporary decor. Heavy gage steel plenums incorporate a large dust/dirt collection area that catches anything that might fall through the diffuser face.

Model NLYD-VC provides variable air volume cooling only control for non-ducted (pressurized floor plenum) applications. A 90° rotation (CCW to open) low leakage damper and integral modulating actuator provide precise airflow control.

FEATURES:

- Meets all the requirements of NFPA 90A.
- Complete assembly including actuator is UL tested and classified in accordance with UL standard 2043.
- Simple installation, unit fits into place from the top (room side) of the floor panel.
- 9" (229) overall height allows installation in 9" (229) raised access floors.
- Five available heavy duty core styles to choose from (see following page).
- All heavy duty cores are removable and supplied with core clips as standard.
- Two available frame options (Frame F or H).
- Standard fastening is Type B friction spring clips.
- Compact 24 VAC direct drive proportional actuator c/w cover.
- Minimum and maximum airflow limits are achieved by limiting the range of the control signal.
- Actuator features two RJ12 ports for simple interconnection using modular plenum rated cables. Multiple units can be 'daisy-chained' together.
- Optional thermostat, thermostat cable and power supply modules are available (see following pages).
- Optional Type DV directional vanes provide an adjustable discharge pattern to enhance coverage of perimeter windows and reduce throw.
- Optional BKP black painted finish on interior plenum surfaces.
- Standard finish is AW Appliance White.
- All sheet metal constructions 18 gauge.



NAILOR INDUSTRIES INC.
FLOOR DIFFUSER
AS TO HEAT RELEASE RATE AND SMOKE OPTICAL DENSITY ONLY
R21545 25KU

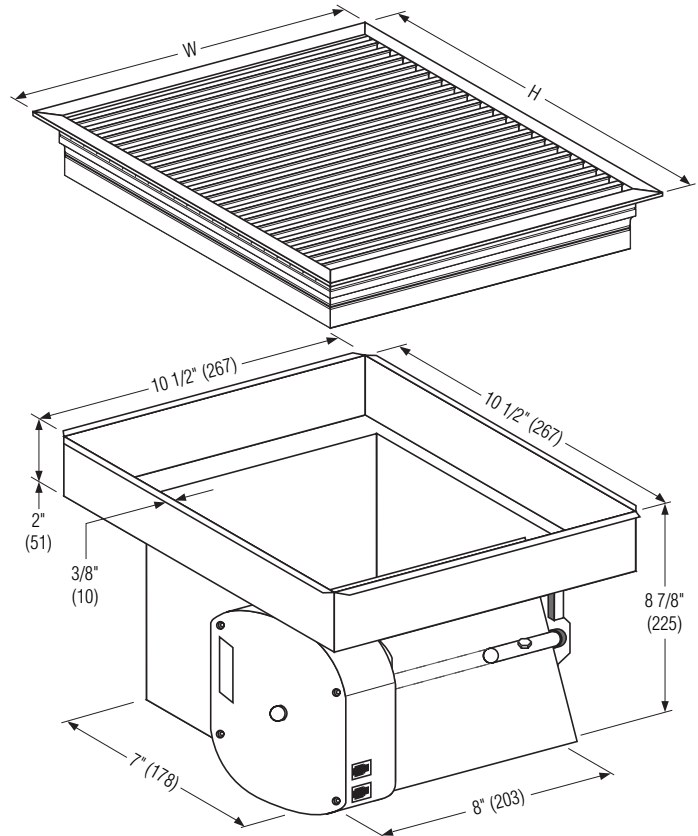

FLOOR OPENING = 10 3/4" x 10 3/4" (273 x 273)
W OR H = 12 1/8" (308) FOR FRAME F OR 11 5/8" (295) FOR FRAME H

SCHEDULE TYPE:		Page 1 of 3			
PROJECT:		Dimensions are in inches (mm).			
ENGINEER:	DATE	B SERIES	SUPERSEDES	DRAWING NO.	
CONTRACTOR:	2 - 12 - 07	NLD	8 - 30 - 05	NLYD-VC	

1. CORE SELECTION:

- 480 - 1/8" (3) Bars - 1/4" (6) Spacing
 - 0° Deflection
 (Standard)

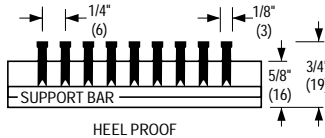

- 481 - 1/8" (3) Bars - 1/4" (6) Spacing
 - 15° Deflection

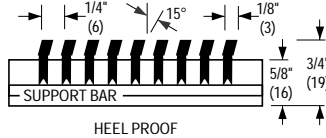

- 240 - 1/4" (6) Bars - 1/2" (13) Spacing
 - 0° Deflection

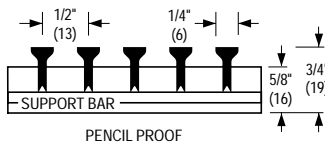

- 241 - 1/4" (6) Bars - 1/2" (13) Spacing
 - 15° Deflection

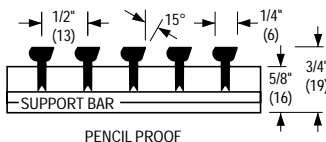

- 243 - 1/4" (6) Bars - 1/2" (13) Spacing
 - 30° Deflection

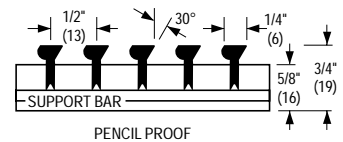

2. FRAME SELECTION:

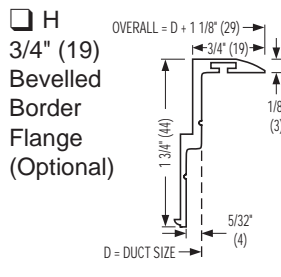
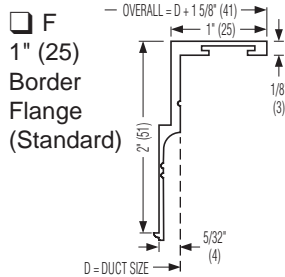

3. FASTENING SELECTION:

- TYPE B**
 Spring Clip
 (Frames F or H)
 (Standard)

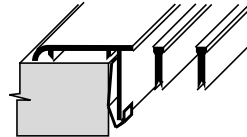

- TYPE A**
 #8 Countersunk Screw
 Holes. (Frame F only)
 (Optional)

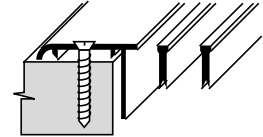

4. ACTUATOR CABLE SELECTION:

- 12 12 ft. long (Standard)
 20 20 ft. long

5. FINISH SELECTION:

- AW Appliance White (Standard)
 GRT Gray (textured)
 BKT Black (textured)
 AL Aluminum
 SA Satin (clear) Anodized
 BC Brushed clear-coat lacquer
 MI Mill
 BK Black
 SP Special _____ .
 SPT Special (textured) _____ .

6. OPTIONS:

- DV** Directional Vanes
 Fully adjustable extruded
 aluminum blades on 3/4" (19)
 centers perpendicular to length.

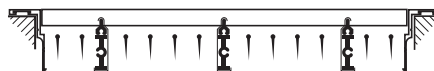

- BKP** Plenum interior
 painted black.

SCHEDULE TYPE:

PROJECT:

ENGINEER:

CONTRACTOR:

Page 2 of 3
 Dimensions are in inches (mm).

DATE

B SERIES

SUPERSEDES

DRAWING NO.

2 - 12 - 07

NLD

8 - 30 - 05

NLYD-VC

VAV LINEAR FLOOR DIFFUSER CONTROL DIAGRAM

UNDERFLOOR AIR DISTRIBUTION SYSTEMS

VAV • COOLING ONLY • NON-DUCTED

MODEL: NLYD-VC

DESCRIPTION:

The Nailor NLYD floor diffuser is designed to provide VAV control in cooling only applications. Advanced micro-computer electronics and P+I control algorithms provide precise temperature control.

CONTROL FEATURES:

- Fast connection/wiring between units with RJ12 (phone jack) connections. Allows units to be quickly installed or relocated.
- Compact direct-drive 24 VAC actuator utilizes a 2 – 10 VDC control signal for precise airflow control.
- Standard 12 ft. modular plenum rated cables, for interconnection between diffusers, allows diffusers to be spaced on 10 ft. intervals (20 ft. cables optional).
- Power supply modules allow connection of up to 12 units on each line voltage connection (6 diffusers on each side) (8 units total or 4 on each side with optional 20 ft. cables).
- Each thermostat can control a maximum of 3 power supplies.
- Minimum and maximum airflow limits are adjusted underneath the thermostat cover.

ACCESSORIES:

1. Thermostat
 - NCTE-5015-10 °F Scale
 - NCTE-5015-11 °C Scale
2. Cables:
 - NHSO-5012 50 ft. Thermostat Cable
3. Power Supply Module (includes NHSO-5011 transformer cable, NHSO-5010 3-way connector and transformer mounted & wired in a sheetmetal enclosure):
 - NPS-120 120 Volt Supply Voltage
 - NPS-277 277 Volt Supply Voltage
 - NPS-240 240 Volt Supply Voltage
 - NPS-480 480 Volt Supply Voltage
4. Special Features: _____

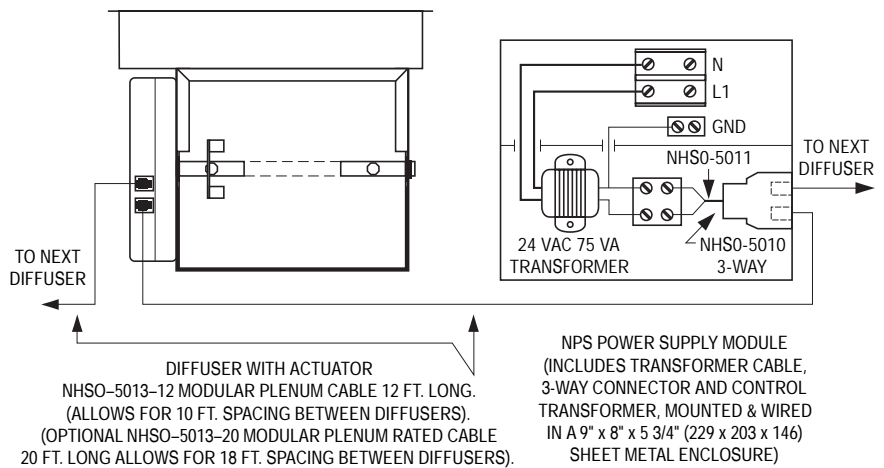

DETAIL A

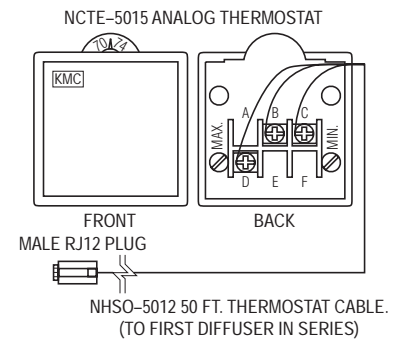

DETAIL B

SYSTEM OVERVIEW (SIDE VIEW):

A maximum of six actuators can be daisy chained on each side of a power supply module (4 actuators with optional 20 ft. cables). This allows a maximum of twelve actuators per power supply (8 actuators total with optional 20 ft. cables). Each thermostat can handle up to three power supply/actuator sub-systems for a total of up to thirty-six diffusers per thermostat, (24 diffusers with optional 20 ft. cables).

CONNECTION TO DDC CONTROLS:

The standard thermostat provides a direct acting 2 – 10 VDC control signal (Terminal D) to the actuator (Terminal B is Common). These wires can be connected to another signal source for control by the BMS. For cooling only units a 10 VDC signal will drive the damper fully open (CCW) to provide maximum airflow. Similarly a 2 VDC signal (or less) will drive the damper fully closed.

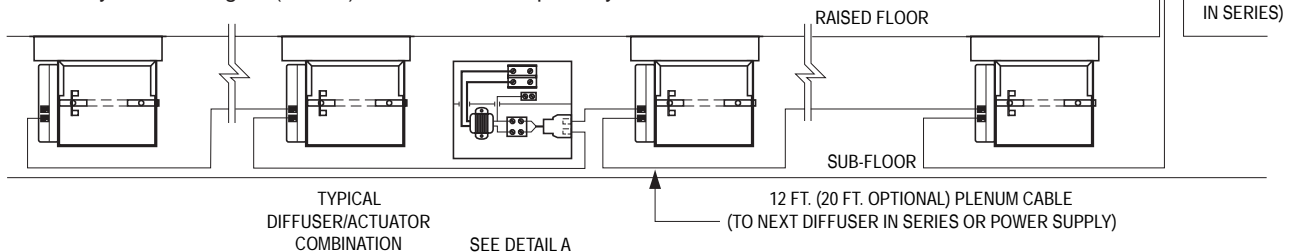

SCHEDULE TYPE:

PROJECT:

ENGINEER:

CONTRACTOR:

Page 3 of 3
Dimensions are in inches (mm).

DATE

B SERIES

SUPERSEDES

DRAWING NO.

2 - 12 - 07

NLD

8 - 30 - 05

NLYD-VC